

Varenummer: 204250M850D3S
 Beskrivelse: E+G Justerfod
 GN 42-50-M8-50-D3-S
 Note: S Uden møtrik, udvendig sekskant i bunden

Mål

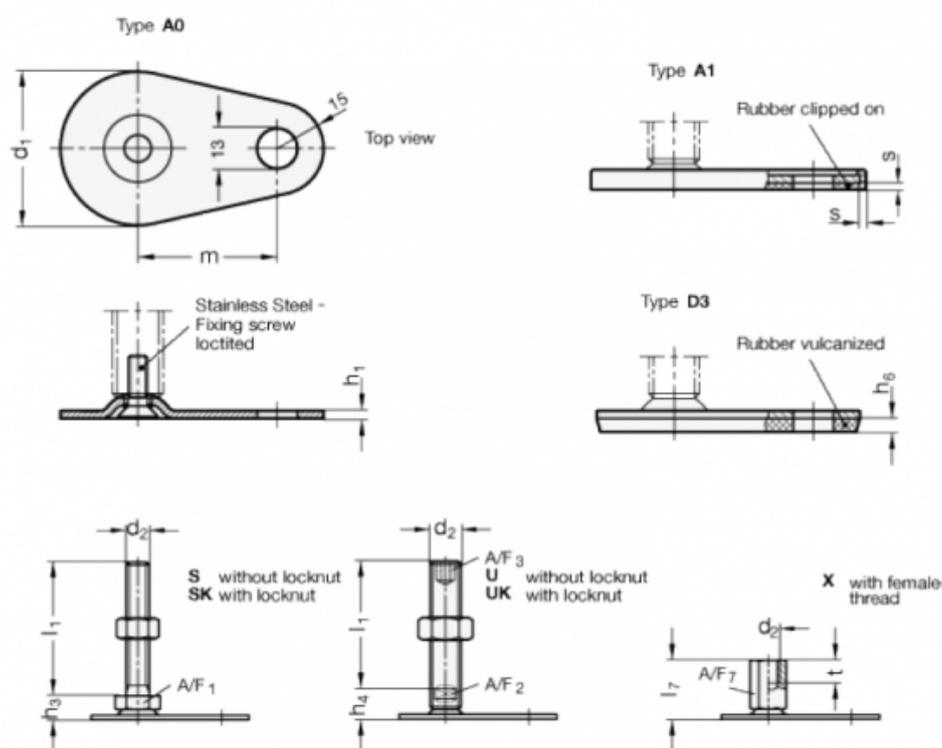

A/F1 = 17

d1 = 50

d2 = M8

h1 = 2.5

h3 = 11

h6 = 4

l1 = 50

m = 45

s =